

DHI-VTO4103F-X Series

Module



Technical Specification

Model	DHI-VTO4103F-MB1
System	
Main Processor	Embedded Processor
Button Type	Mechanical
Performance	
Casing Material	Aluminum alloy
Port	
Power Output	5 VDC (provides power for other modules)
General	
Appearance Color	Silver
Power Supply	5 VDC (provided by other modules)
Installation	Flush Mount; Surface Mount
Product Dimensions	100 mm × 49.90 mm × 30.50 mm (3.94" × 1.96" × 1.20")
Protection	IK07; IP65 (silicone sealant is needed for installation)
Operating Temperature	-20 °C to +60 °C (-22 °F to +140 °F)
Operating Humidity	10%–90% (RH)
Power Consumption	≤0.5 W
Gross Weight	0.18 kg (0.40 lb)

Technical Specification

Model	DHI-VTO4103F-MB2
System	
Main Processor	Embedded Processor
Button Type	Mechanical
Performance	
Casing Material	Aluminum alloy
Port	
Power Output	5 VDC (provides power for other modules)
General	
Appearance Color	Silver
Power Supply	5 VDC (provided by other modules)
Installation	Flush Mount; Surface Mount
Product Dimensions	100 mm × 49.90 mm × 30.50 mm (3.94" × 1.96" × 1.2")
Protection	IK07; IP65(silicone sealant is needed for installation)
Operating Temperature	-20 °C to +60 °C (-22 °F to +140 °F)
Operating Humidity	10%–90% (RH)
Power Consumption	≤0.5 W
Gross Weight	0.17 kg (0.37 lb)

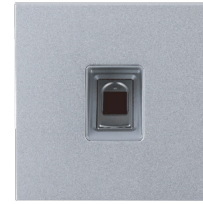
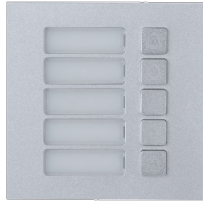

Technical Specification

Model	DHI-VTO4103F-MB5
System	
Main Processor	Embedded Processor
Button Type	Mechanical
Performance	
Casing Material	Aluminum alloy
Port	
Power Output	5 VDC (provides power for other modules)
General	
Appearance Color	Silver
Power Supply	5 VDC (provided by other modules)
Installation	Flush Mount; Surface Mount
Product Dimensions	100 mm × 100 mm × 30.50 mm (3.94" × 3.94" × 1.2")
Protection	IK07; IP65 (silicone sealant is needed for installation)
Operating Temperature	-20 °C to +60 °C (-22 °F to +140 °F)
Operating Humidity	10%–90% (RH)
Power Consumption	≤0.5 W
Gross Weight	0.31 kg (0.68 lb)

Technical Specification

Model	DHI-VTO4103F-MF
System	
Main Processor	Embedded Processor
Performance	
Casing Material	Aluminum alloy
Port	
Power Output	5 VDC (provides power for other modules)
General	
Appearance Color	Silver
Power Supply	5 VDC (provided by other modules)
Installation	Flush Mount; Surface Mount
Product Dimensions	100 mm × 100 mm × 38.50 mm (3.94" × 3.94" × 1.52")
Protection	IK07; IP65 (silicone sealant is needed for installation)
Operating Temperature	-20 °C to +60 °C (-22 °F to +140 °F)
Operating Humidity	10%–90% (RH)
Power Consumption	≤0.5 W
Gross Weight	0.33 kg (0.73 lb)

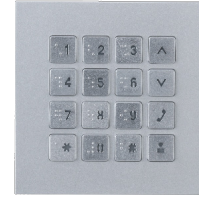

Technical Specification

Model	DHI-VTO4103F-MI
Performance	
Casing Material	Aluminum
General	
Appearance Color	Silver
Power Supply	5 VDC (Provided with power by other modules)
Certifications	CE
Product Dimensions	100.0 mm × 100.0 mm × 28.5 mm (3.94" × 3.94" × 1.12")
Protection	IK07;IP65(silicone sealant is needed for installation)
Operating Temperature	-30°C to +60°C (-22°F to +140°F)
Operating Humidity	10%–90% (RH), non-condensing
Operating Environment	Outdoor
Operating Altitude	0 m–3,000 m (0 ft–9,842.52 ft)
Power Consumption	≤0.5 W
Gross Weight	0.28 kg (0.62 lb)
Storage Temperature	0 °C to +40 °C (+32 °F to +104 °F)
Storage Humidity	30%–75% (RH), non-condensing

Technical Specification

Model	DHI-VTO4103F-MK
System	
Main Processor	Embedded Processor
Button Type	Mechanical
Performance	
Casing Material	Aluminum alloy
Port	
Power Output	5 VDC (provides power for other modules)
General	
Appearance Color	Black
Power Supply	5 VDC (provided by other modules)
Installation	Flush Mount;Surface Mount
Product Dimensions	100 mm × 100 mm × 31 mm (3.94" × 3.94" × 1.22")
Protection	IK07;IP65(silicone sealant is needed for installation)
Operating Temperature	-20 °C to +60 °C (-22 °F to +140 °F)
Operating Humidity	10%–90% (RH)
Power Consumption	≤0.5 W
Gross Weight	0.32 kg (0.71 lb)

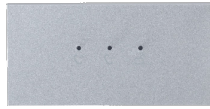

Technical Specification

Model	DHI-VTO4103F-ML
System	
Main Processor	Embedded Processor
Performance	
Casing Material	Aluminum alloy
Port	
Power Output	5 VDC (provides power for other modules)
General	
Appearance Color	Silver
Power Supply	5 VDC (provided by other modules)
Installation	Flush Mount; Surface Mount
Product Dimensions	100 mm × 49.90 mm × 28.50 mm (3.94" × 1.96" × 1.12")
Protection	IK07; IP65 (silicone sealant is needed for installation)
Operating Temperature	-20 °C to +60 °C (-22 °F to +140 °F)
Operating Humidity	10%–90% (RH)
Power Consumption	≤2 W
Gross Weight	0.19 kg (0.42 lb)

Technical Specification

Model	DHI-VTO4103F-MN
Performance	
Casing Material	Aluminum alloy
General	
Appearance Color	Silver
Installation	Flush Mount; Surface Mount
Product Dimensions	100 mm × 49.90 mm × 28.50 mm (3.94" × 1.96" × 1.12")
Protection	IK07; IP65 (silicone sealant is needed for installation)
Operating Temperature	-20 °C to +60 °C (-22 °F to +140 °F)
Operating Humidity	10%–90% (RH)
Gross Weight	0.17 kg (0.37 lb)
Power Consumption	≤0.5 W
Gross Weight	0.32 kg (0.71 lb)



Technical Specification

Model	DHI-VTO4103F-MR1
System	
Main Processor	Embedded Processor
Function	
Card Type	ID card
RFID	
Modulation Type	AM
Frequency Range	125 kHz
Max. Transmission Power	66 dBuA/m @10 m
Performance	
Card Reading Distance	1 cm–3 cm (0.39"–1.18")
Casing Material	Aluminum alloy
Port	
Power Output	5 VDC (provides power for other modules)
General	
Appearance Color	Silver
Power Supply	5 VDC (provided by other modules)
Installation	Flush Mount; Surface Mount
Product Dimensions	100 mm × 49.90 mm × 28.50 mm (3.94" × 1.96" × 1.12")
Protection	IK07; IP65 (silicone sealant is needed for installation)
Operating Temperature	–20 °C to +60 °C (–22 °F to +140 °F)
Operating Humidity	10%–90% (RH)
Power Consumption	≤2 W
Gross Weight	0.16 kg (0.35 lb)

Technical Specification

Model	DHI-VTO4103F-MR
System	
Main Processor	Embedded Processor
Function	
Card Type	IC card
RFID	
Modulation Type	AM
Frequency Range	13.56 MHz
Max. Transmission Power	42 dBuA/m @10 m
Performance	
Card Reading Distance	1 cm–3 cm (0.39"–1.18")
Casing Material	Aluminum alloy
Port	
Power Output	5 VDC (provides power for other modules)
General	
Appearance Color	Silver
Power Supply	5 VDC (provided by other modules)
Installation	Flush Mount; Surface Mount
Product Dimensions	100 mm × 49.90 mm × 28.50 mm (3.94" × 1.96" × 1.12")
Protection	IK07; IP65 (silicone sealant is needed for installation)
Operating Temperature	–20 °C to +60 °C (–22 °F to +140 °F)
Operating Humidity	10%–90% (RH)
Power Consumption	≤2 W
Gross Weight	0.16 kg (0.35 lb)

Installation

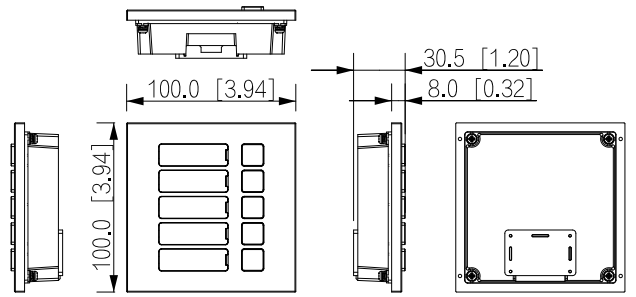
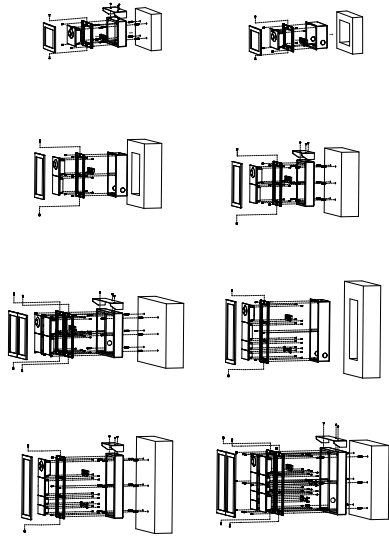

DHI-VTO4103F-MB5

Dimensions (mm[inch])

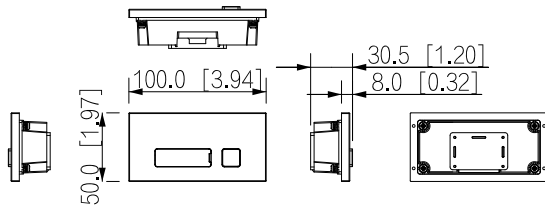

DHI-VTO4103F-MB1

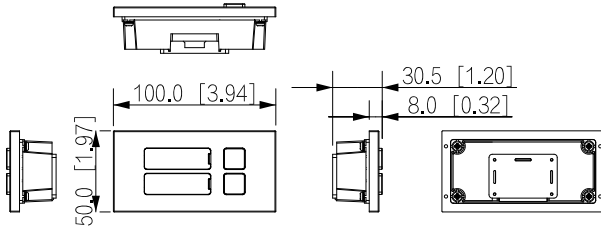

DHI-VTO4103F-MB2

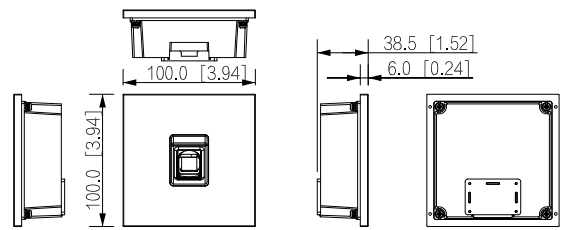

DHI-VTO4103F-MF

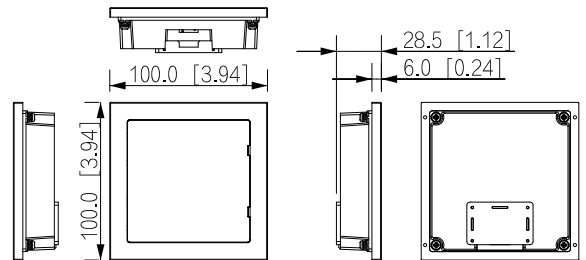

DHI-VTO4103F-MI

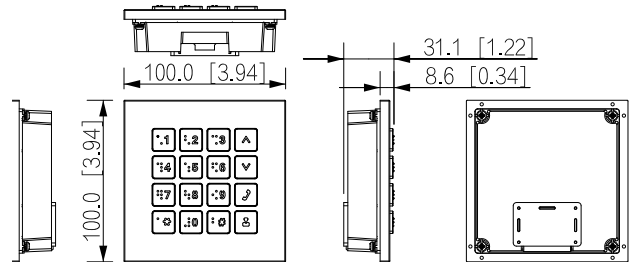

DHI-VTO4103F-MK

DHI-VTO4103F-X Series

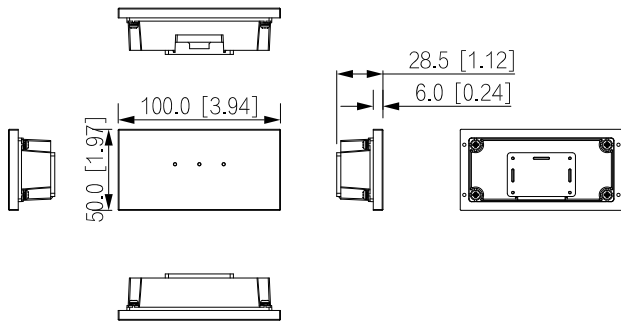

DHI-VTO4103F-ML

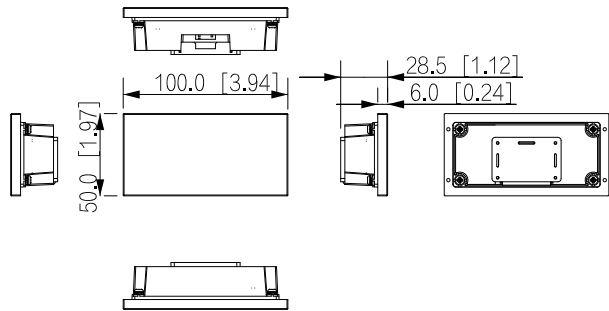

DHI-VTO4103F-MN

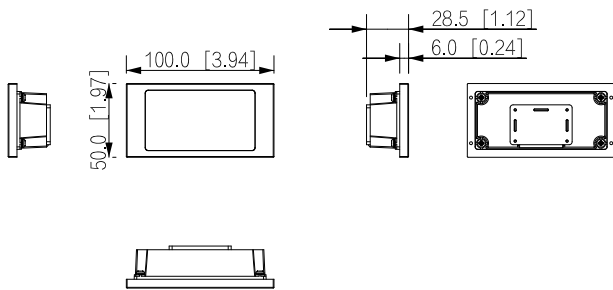

DHI-VTO4103F-MR.DHI-VTO4103F-MR1